



## Teralux Neo Panel 10 Inch Zigbee Gateway User Manual



**Teralux Office**

Komp. Ruko Harmoni Mas, Jl. Jemb. Dua Raya  
No.15 blok A, RT.1/RW.3, Pejagalan, Penjaringan,  
North Jakarta City, Jakarta 14450

# Teralux Nexus Panel 7 Zigbee Gateway

This product is suitable for indoor public spaces and integrates a multi-functional control panel that combines control, interconnection, entertainment, and security functions.

Compatible with a variety of product forms, it is designed with standard bases for different countries and can be installed using a wall bracket to securely fix the control panel to the wall.

It mainly provides gateway functions, scene control, device video interconnection, and other related features. Users can control and manage different types of devices under the same account through physical buttons, the touch screen, voice commands, and other interactive methods.

## Features

Combines Zigbee, BLE, Wi-Fi, RS-485, infrared, and relay control into one powerful smart home interface.

Certified Alexa enables hands-free voice control for lighting, climate, scenes, and smart devices.

Customized Android system with stable connectivity, Ethernet support, and local relay control for dependable operation.

Full-HD touchscreen and proximity sensor deliver fast, smooth, and user-friendly control.

Supports AC or DC power, flush wall mounting, and seamless Tuya app integration for high-end spaces.

Built-in infrared emitters allow easy control of traditional devices like TVs and air conditioners.

Supports 100+ Zigbee and BLE devices, making it ideal for expanding smart home and commercial systems.

## Mechanical Structure

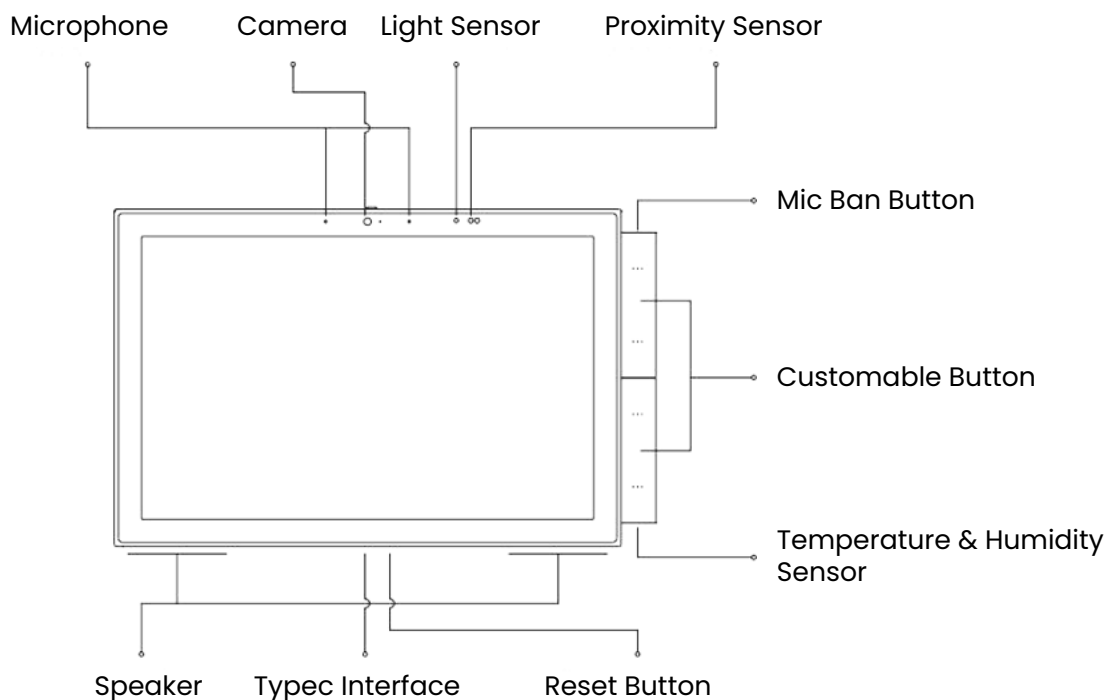

## Technical Parameter

### Teralux Nexus Panel 7 Inch Zigbee Gateway

Control smart devices effortlessly using voice commands. Easily link more than 100 devices. Interact with visitors directly through the panel. Adjust language preferences for worldwide compatibility.

Attribute	Parameter	Specification
Product Attributes	Product Type	Zigbee Protocol Smart Home Gateway
	Touch Type	Capacitive Multi-point Touch
	Memory	RAM 2GB + ROM 8GB
	Screen Size	10.1" (1920 × 1200)
	Protocols	Wi-Fi (2.4GHz), Zigbee 3.0, BLE, RS-485
	Camera	Built-in 5MP HD Camera with Privacy Shutter
	IR Support	Built-in with 3 IR Emitters
	Switch Configuration	Customizable 2 Buttons + 2-Gang Relay
	Built-in Speaker	2 Speakers
	Supported Devices	128+ Devices
	Technical Parameter	Input
Switch		100-240V~, 50/60Hz 10A(two-way relay)
Single load		200W
Total load		400W
Single-channel load		RJ45 network port×1
Package	Dimensions	250 × 133 × 38 mm

# Product Installation

## Installation preparation

This product is powered by the neutral wire, please arrange the neutral wire in advance. This product is connected to the network through Wi-Fi or Ethernet, please arrange the Wi-Fi network or Ethernet cable in advance. If you need to use the relay, RS485, security network port of this product, please preset the relevant cables in advance. In order to ensure electricity safety and wireless performance, please use the standard plastic box for installation and use. Please bring your own screwdriver, test pen, electrical tape and other tools, please do not operate with electricity.

## Installation Instructions

Turn off the main power switch, and use a test pen to confirm that the live wire of the cassette is not charged. Connect the base correctly, make sure that the copper wire and the terminal are well released, and there is no exposed wire.

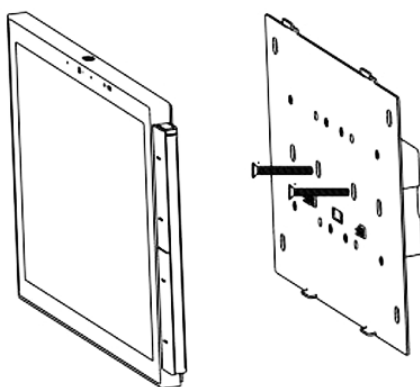
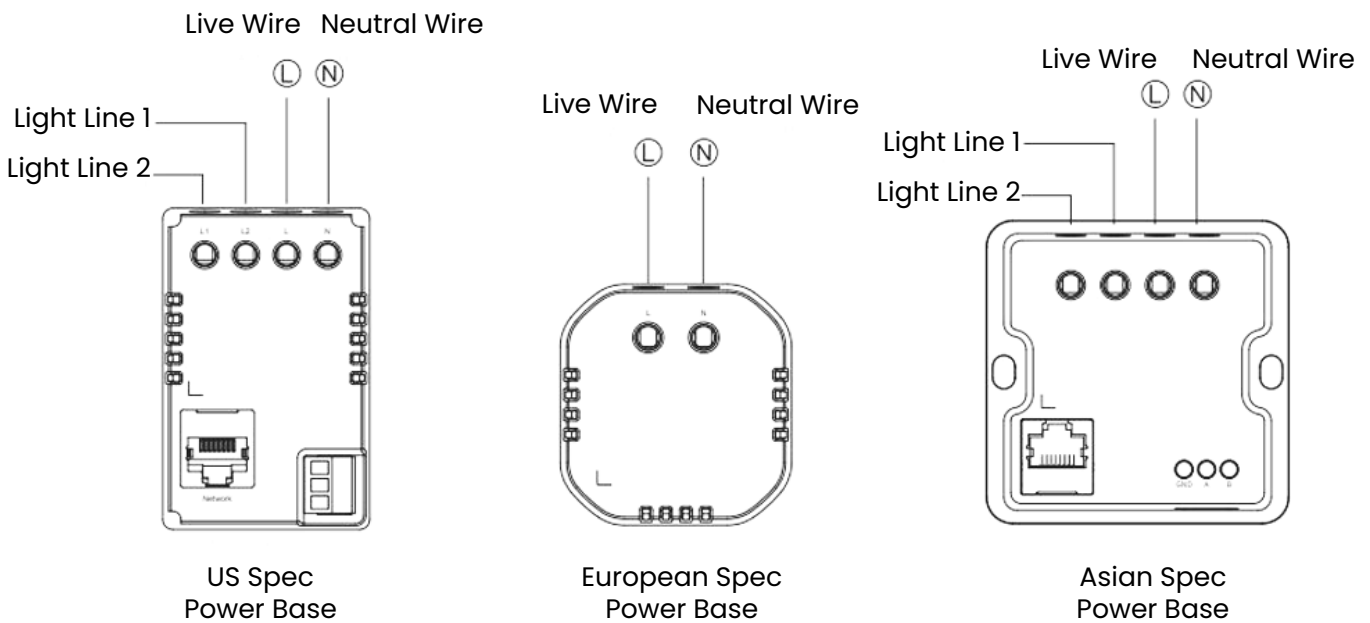

Schematic Diagram of Locking Screw (Including Power Base)

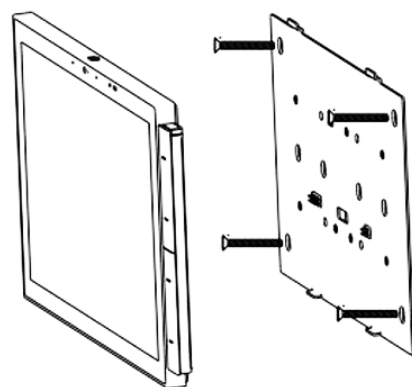

Schematic Diagram of Locking Screw (Without Power Base)

## System Diagram

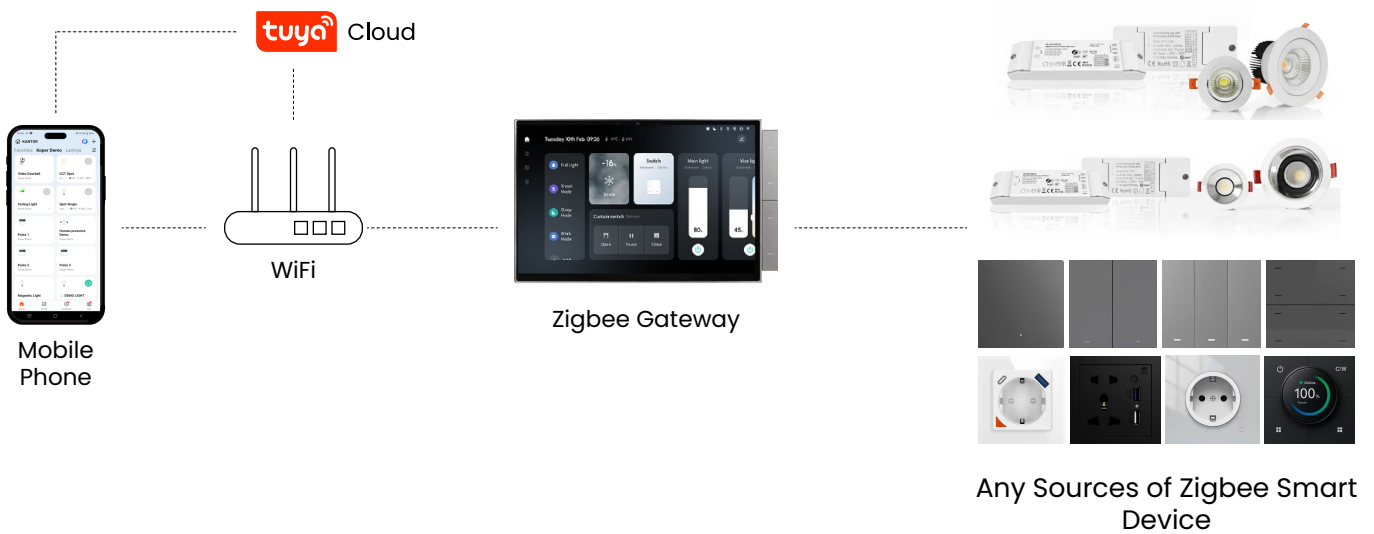

## Pairing Guide

After mounting the Smart Control Panel on the wall and powering it up, it will enter the boot guide page. Follow the on-screen prompts to:

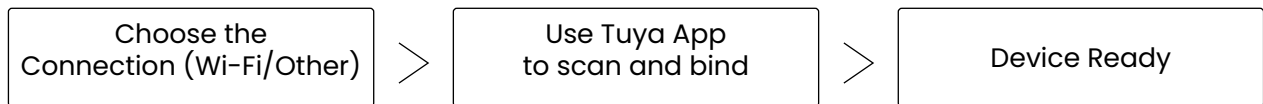

Scroll down to open the menu



Connect to nearby connection

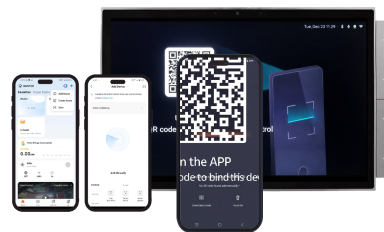

Scan via Tuya App



Device Ready

## Device Search

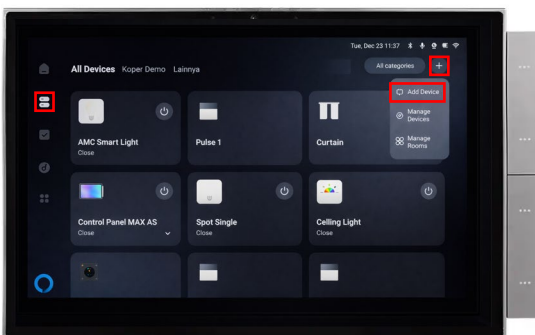

1. Press the Device button on the main screen to enter the device management menu.
2. Tap the "+" button to begin adding a new device.
3. The panel will automatically start scanning for nearby Zigbee smart devices.
4. Once the device appears on the list, select it to complete the connection.

# Mobie Interface Tuya App

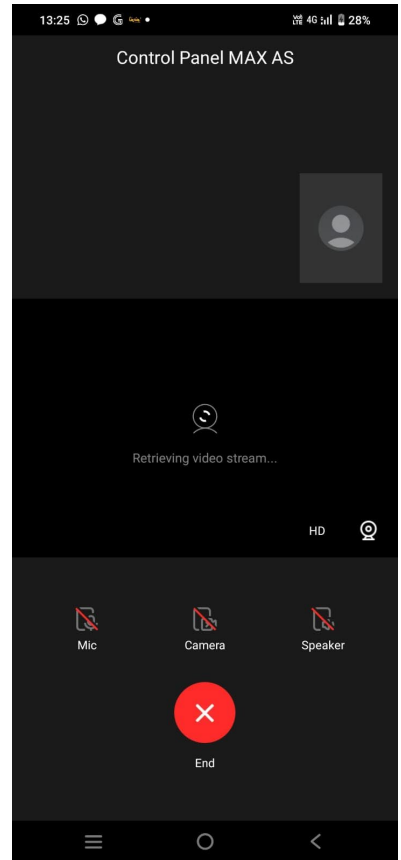
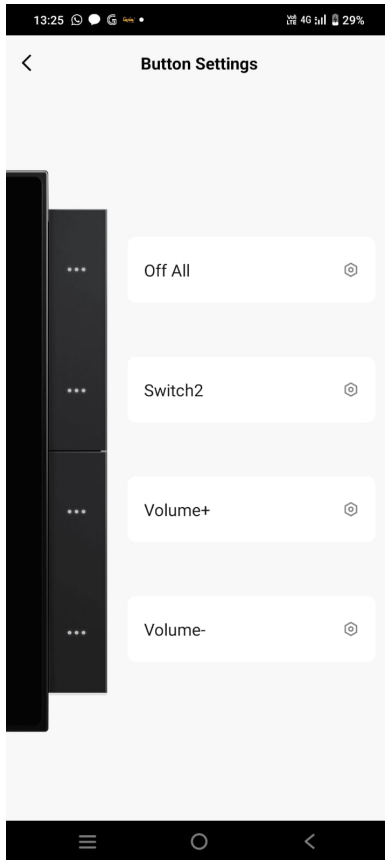
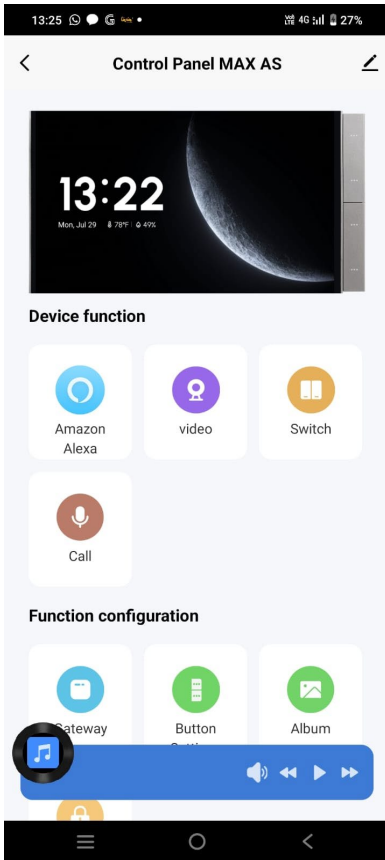



**Teralux Office**

Komp. Ruko Harmoni Mas, Jl. Jemb. Dua Raya  
No.15 blok A, RT.1/RW.3, Pejagalan, Penjaringan,  
North Jakarta City, Jakarta 14450

[teraluxliving.com](http://teraluxliving.com)