

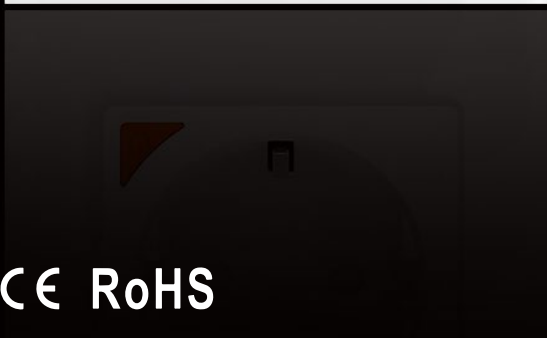

# Teralux Smart Wall Socket EU User Manual



**CE RoHS**

**Teralux Office**

Komp. Ruko Harmoni Mas, Jl. Jemb. Dua Raya  
No.15 blok A, RT.1/RW.3, Pejagalan, Penjaringan,  
North Jakarta City, Jakarta 14450

# Teralux Smart Wall Socket EU

The TERALUX Wi-Fi Smart Wall Socket with USB-C and USB-A brings convenient, intelligent power control to any space. Equipped with overvoltage, overcurrent, and overcharge protection, it ensures safe charging for all your devices. The built-in timer, schedule, cyclic, and random timing features allow fully automated power management, while the jog control function lets the socket turn off automatically after a preset duration. With remote control via Tuya or Smart Life App and hands-free voice compatibility with Alexa and Google Home, this smart socket delivers effortless, modern convenience for everyday use.

## Features

Timer, schedule, cyclic, and random timing modes for fully automated device control.

Built-in overvoltage, overcurrent, and overcharge protection to safeguard connected devices.

Dual charging ports provide convenient and fast power for phones, tablets, and accessories.

Manage your socket anytime, anywhere using Tuya or Smart Life App.

Works seamlessly with Amazon Alexa and Google Home for hands-free voice control.

Automatically turns off after a preset duration to prevent overuse or overheating.

## Product Dimension & Attributes

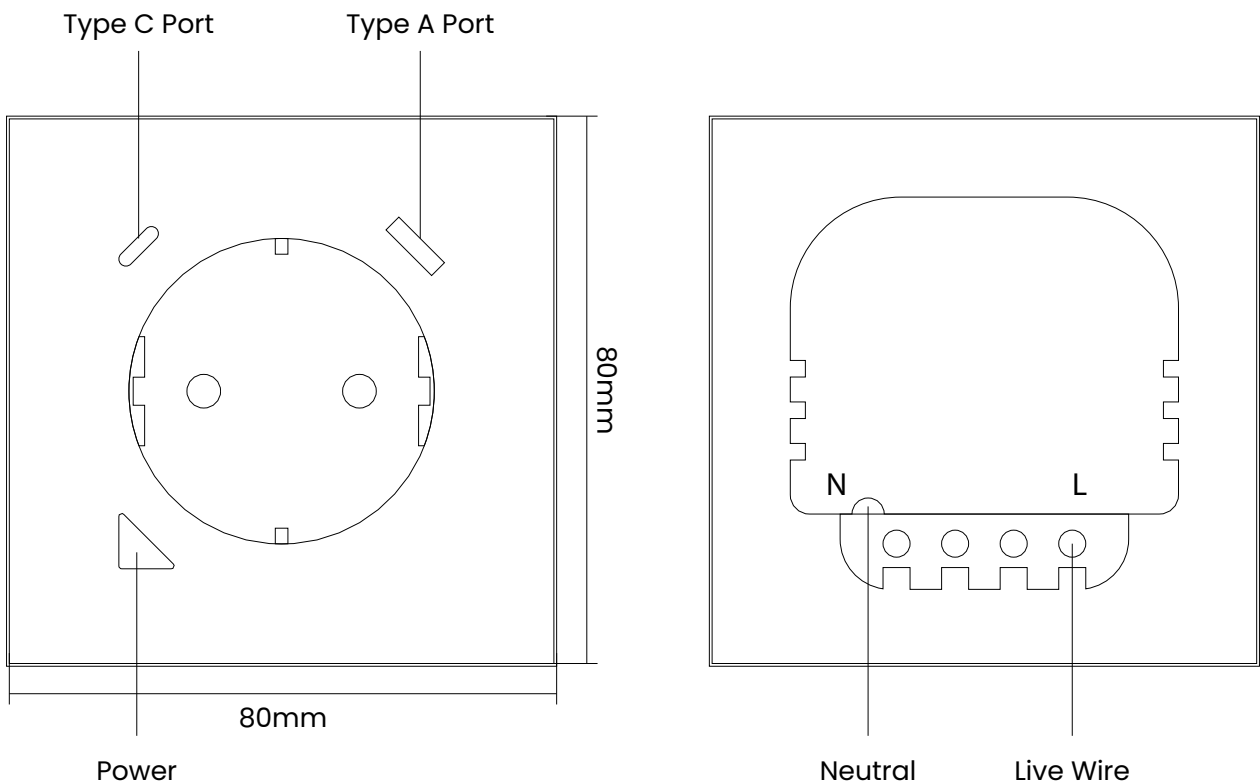

## Technical Parameter

Parameter	Specification
Working Voltage	AC 110-240V (50/60hz)
Normal Load Power	≤3000W
Output	16A (Max)
Maximum Peak Power	3600W
Wireless Protocol	Wi-Fi 2.4Ghz
Wireless Standard	IEEE802.11 b/g/n
App	Tuya App, Smart Life.

## Wiring Diagram

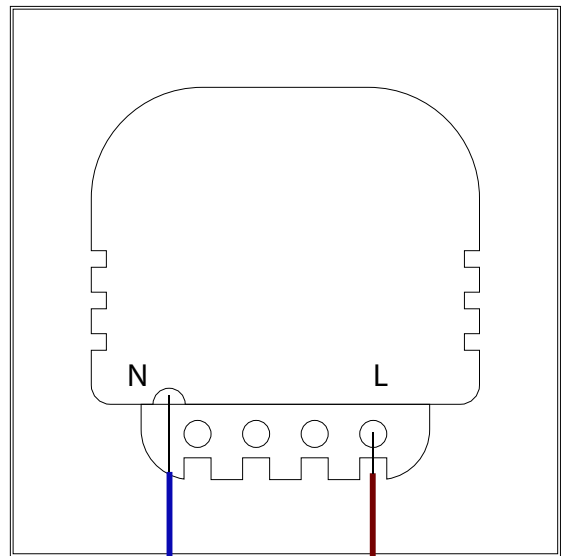
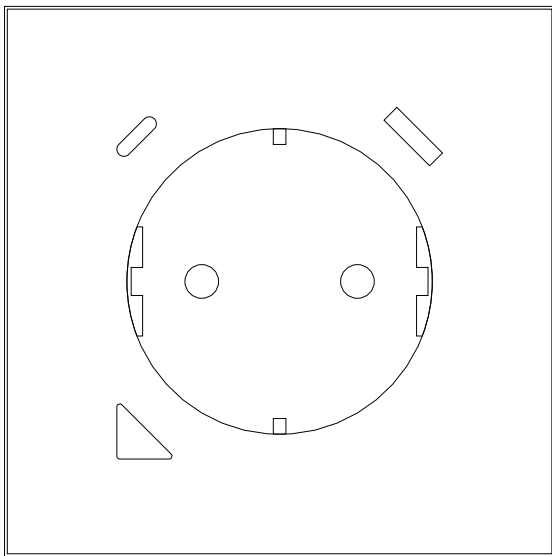

⊗ LED Light    — Live wire    — Neutral wire

# Pairing Instruction

After the Teralux Smart Socket is connected to power, press the power button several times until the indicator light starts blinking, indicating that the device has entered pairing mode.

Open the Tuya app, select Add New Device, then choose Gateway. The Teralux Smart Socket will be detected as an active nearby device and is ready to be connected.

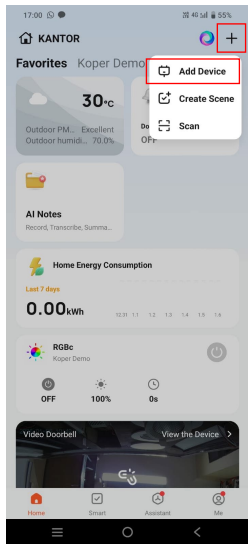

Add New Device

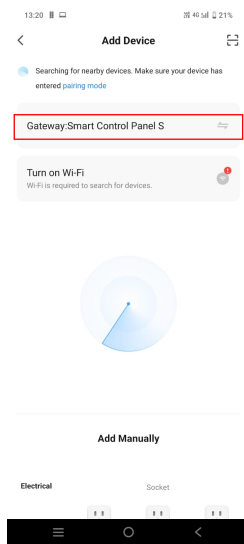

Select Gateway

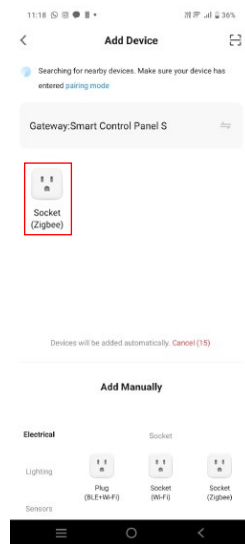

Nearby Device Detected

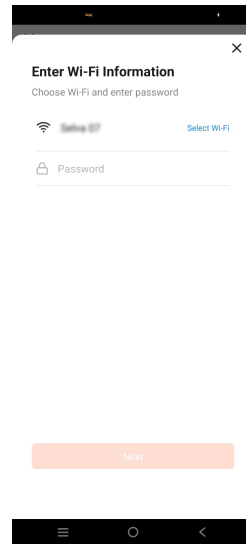

Connect to Nearby Wifi

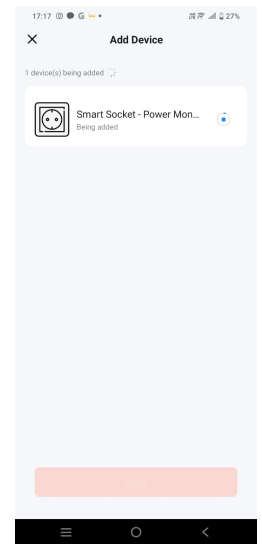

Wait Until The Device Ready

# Device Function

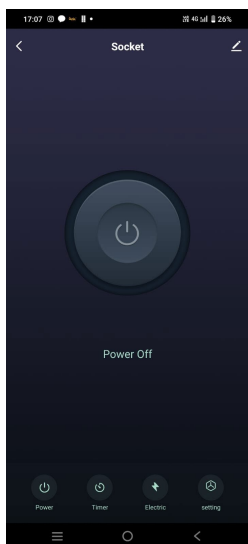

Mobile Power Switch

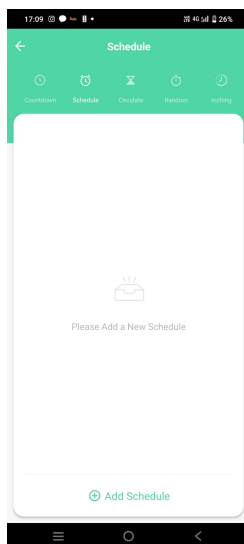

Schedule



Power Information

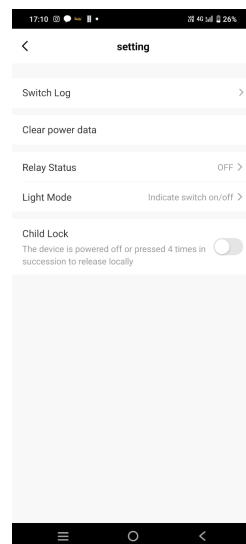

Device Personalization

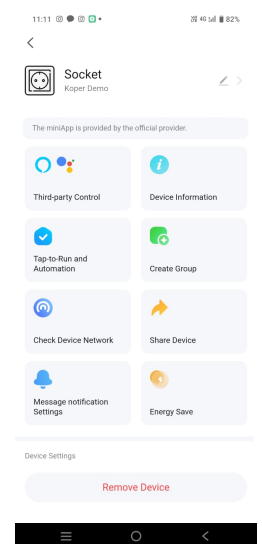

Device Management



**Teralux Office**

Komp. Ruko Harmoni Mas, Jl. Jemb. Dua Raya  
No.15 blok A, RT.1/RW.3, Pejagalan, Penjaringan,  
North Jakarta City, Jakarta 14450

[teraluxliving.com](http://teraluxliving.com)