



Teralux Lumea Spotlight CCT Series User Manual



 Adjustable CCT

Teralux Office

Komp. Ruko Harmoni Mas, Jl. Jemb. Dua Raya
No.15 blok A, RT.1/RW.3, Pejagalan, Penjaringan,
North Jakarta City, Jakarta 14450

teraluxliving.com

Teralux Lumea Spotlight CCT Series

TERALUX Smart CCT Spotlight delivers flexible warm-to-cool white lighting with high color accuracy and a focused, elegant beam. Powered by Zigbee, it offers smooth app and voice control via Tuya, Alexa, and Google Assistant, all wrapped in a premium recessed design for modern interiors.

Features

Easily adjust lighting from warm to cool white to match different moods, activities, or times of day with smooth, precise control.

Delivers natural and true-to-life colors, enhancing interior details, textures, and finishes with premium light quality.

Ensures fast, reliable, and low-latency performance for responsive smart lighting control within your smart home system.

Control brightness, color temperature, scenes, schedules, and automation through the Tuya / Smart Life app or simple voice commands.

Designed with a refined beam angle to create clean, stylish lighting accents without glare.

Built with durable aluminum housing and elegant reflector options, combining efficient heat management with modern aesthetics.

Color Corelated Temperature & Sizing

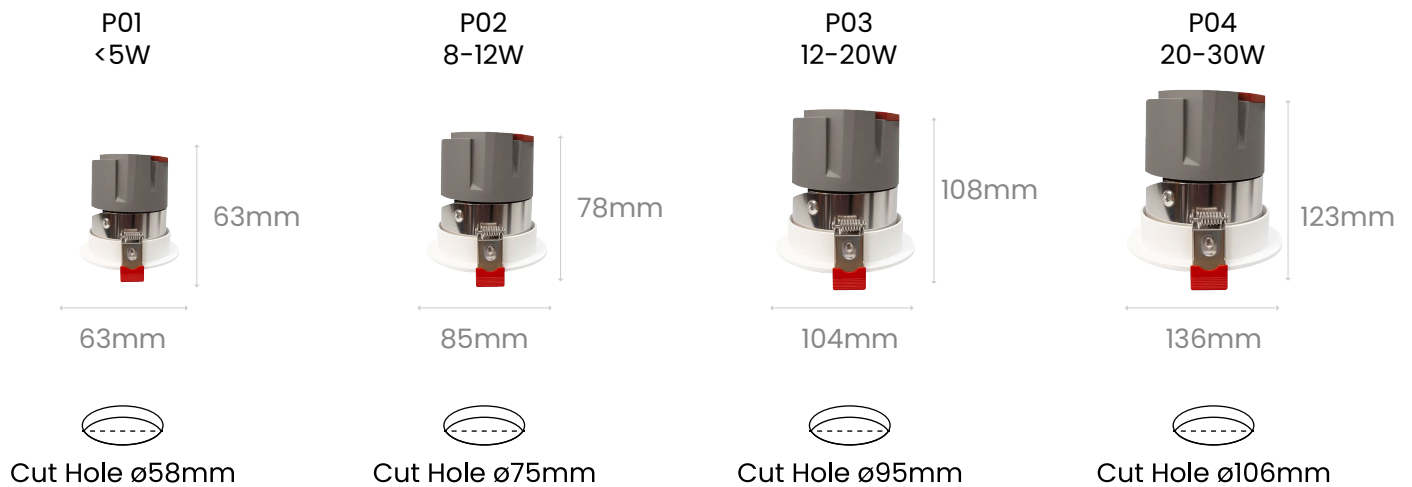
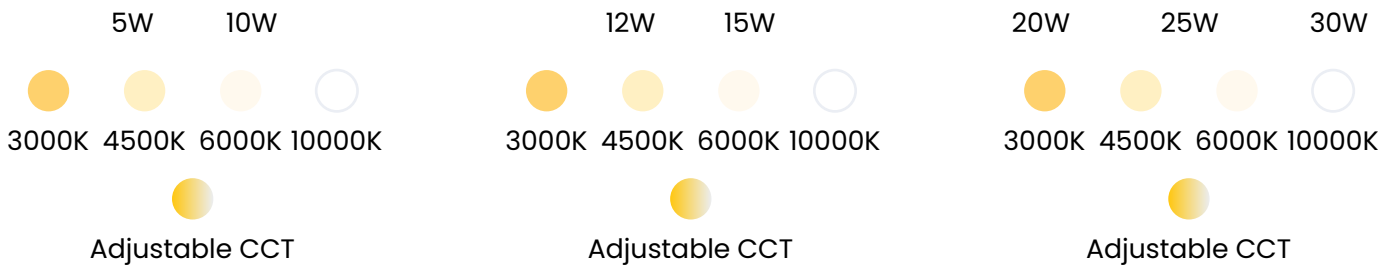

System Wiring

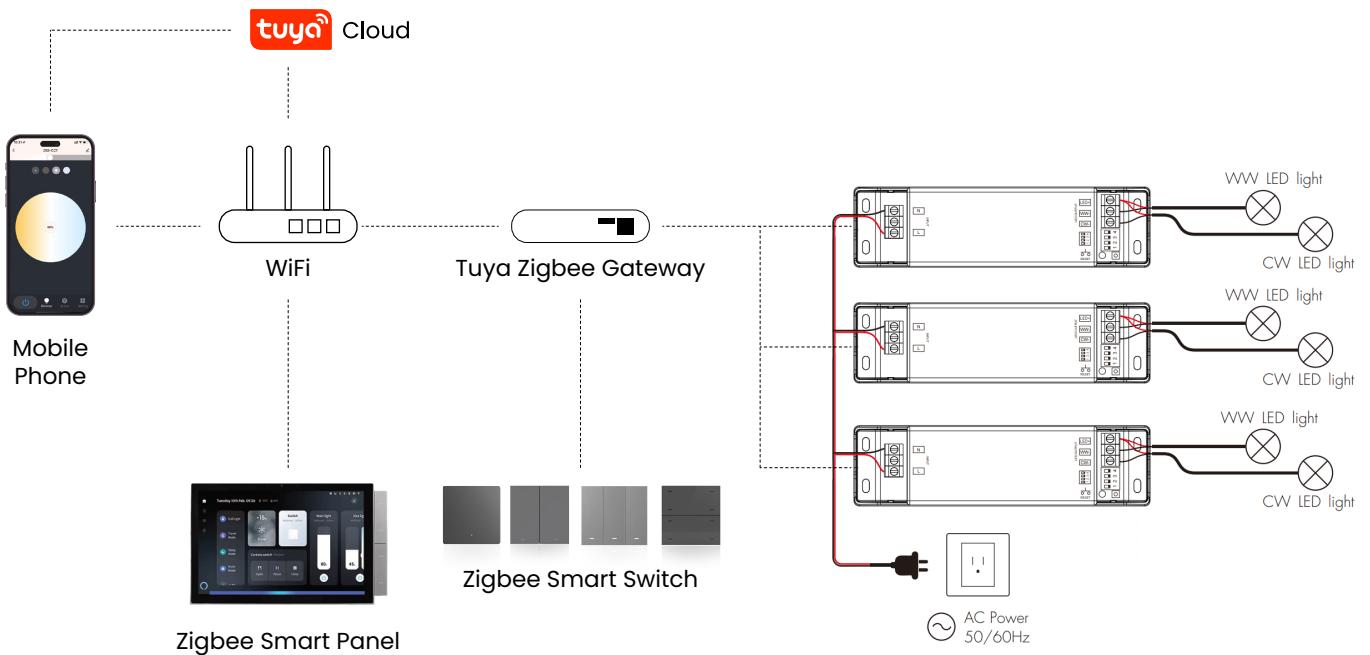

Wiring Diagram

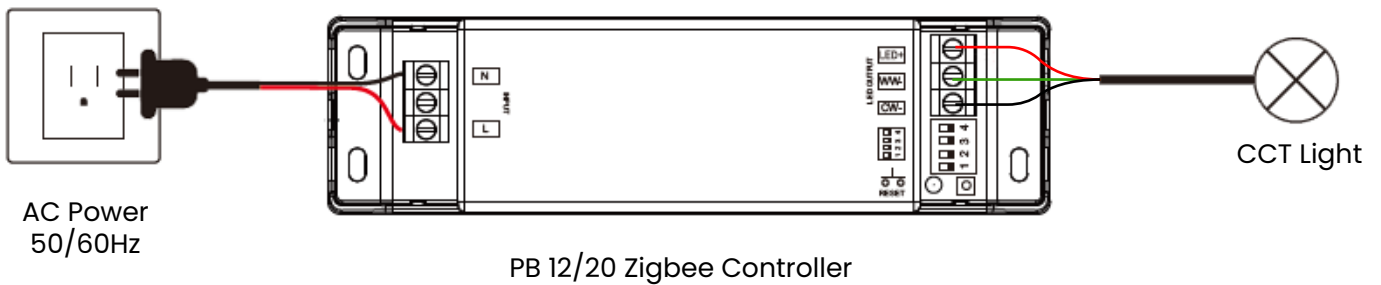

Pairing Guide

Before pairing, ensure the Zigbee gateway is powered on and successfully connected to the Tuya Smart App. Power on the CCT controller and confirm the indicator light is blinking, indicating pairing mode. If the indicator is not blinking, power cycle the device until pairing mode is activated. Open the Tuya Smart App, tap Add Device, select the appropriate lighting category, and follow the on-screen instructions to complete the pairing process. Once connected, the light can be controlled, dimmed, and adjusted for color temperature through the app.

APP Operating Instructions

Network Pairing

To begin network pairing, download the Tuya Smart App and register an account, then search for and add the Tuya ZigBee gateway device. Quickly press the RESET button five times, or power the device on and off five times, to clear any previous network connection. The device will enter pairing mode, indicated by the output light breathing or blinking. Once the gateway is ready, search for and add a new device. If the connection is successful, the ZBS-CCT device will appear in the Tuya App.

App Control Setting

After pairing the light device, you can adjust the brightness and color temperature using the touch brightness slider and color wheel within the app. In the Scene section, four preset scenes are available, and each can be recalled or customized. In the Setting section, you can access additional features such as Plan, Schedule, Timer, Rhythms, and Power-on behavior options.

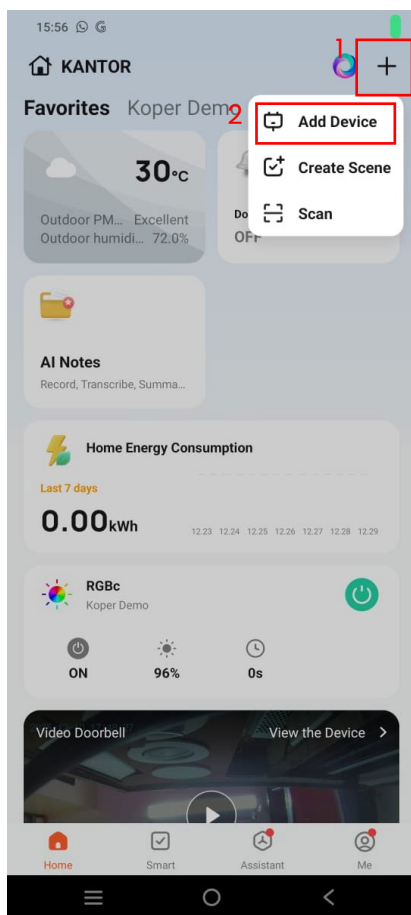

Add New Device

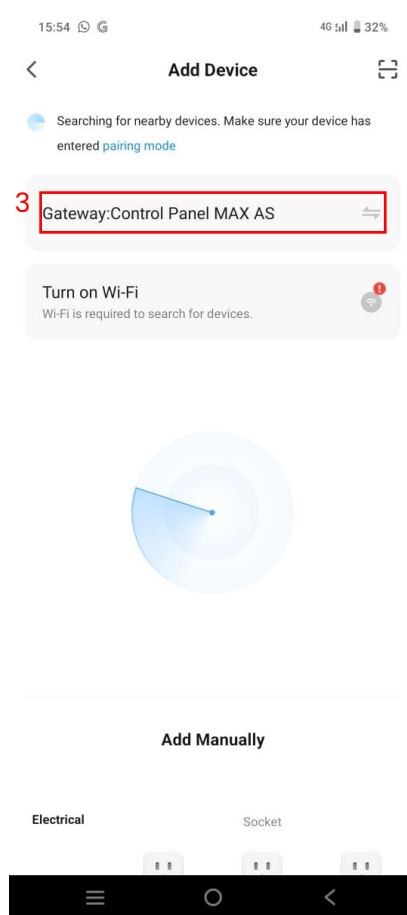

Connect to Nearby Gateway

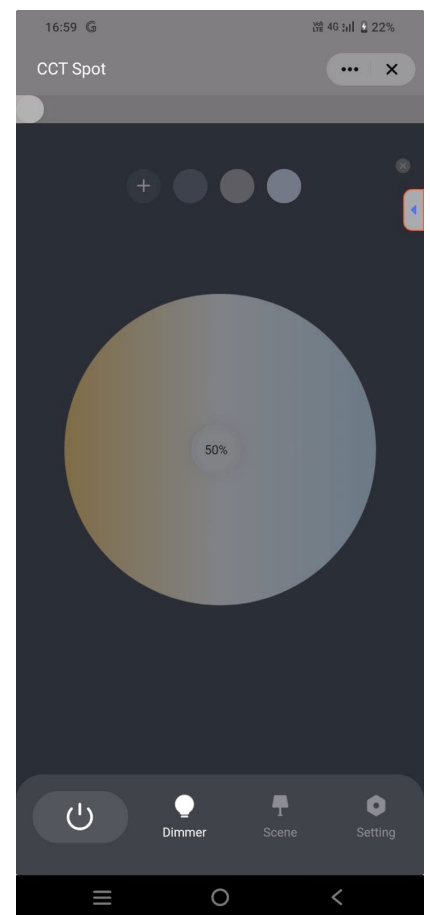

Device Ready



Teralux Office

Komp. Ruko Harmoni Mas, Jl. Jemb. Dua Raya
No.15 blok A, RT.1/RW.3, Pejagalan, Penjaringan,
North Jakarta City, Jakarta 14450

teraluxliving.com